

Application: shaping, broaching and thickening

Machine: shapers, multilateral profile millers, surfacers and thickeners

Characteristics:

- » width 40 mm, thickness 4 mm
- » knives can operate with limiters (manual shift) or without (machine shift)
- » knife material – tool steel, SP
- » limiter material – structural steel, SP
- » the limiter prevents tool “kicking” at manual feed
- » the limiter has a profile cut 0,8 mm deeper

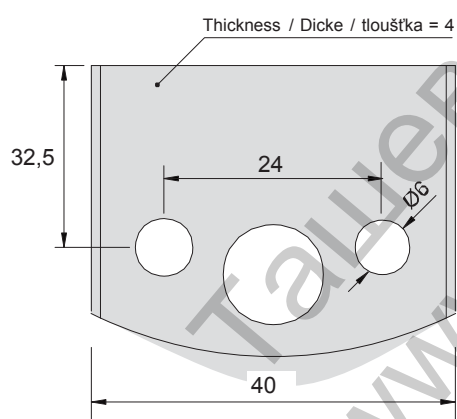
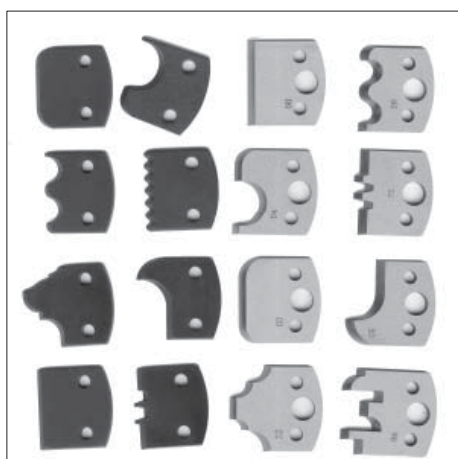

Semiproducts for Profile Cutter Cut

- » Semiproducts of both limiters and profile knives are in the same dimensions
- » For maximum profile depth up to 16 mm

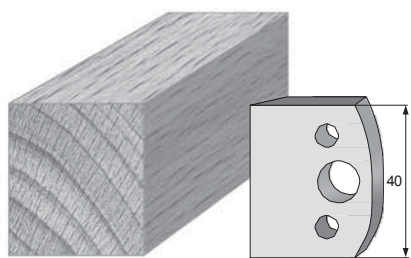

Profile number **00**

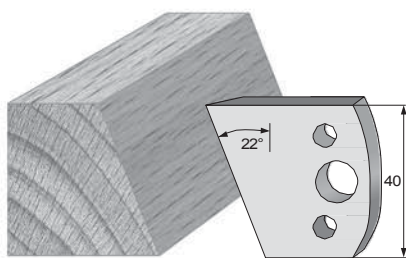

Profile number **01**

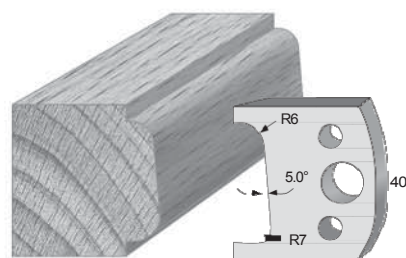

Profile number **02**

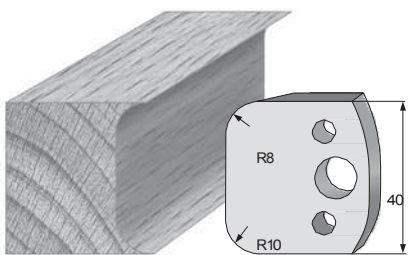

Profile number **03**

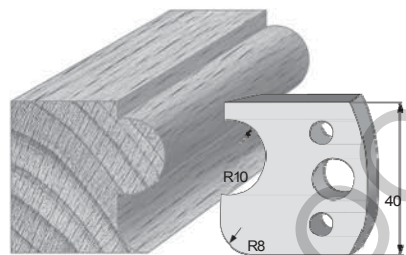

Profile number **04**

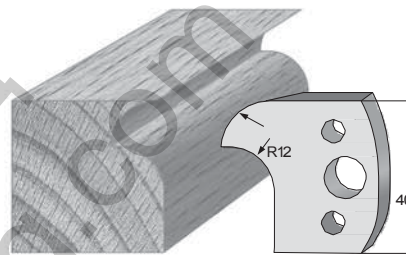

Profile number **05**

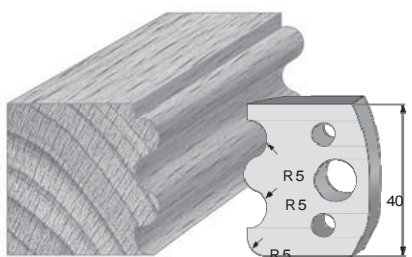

Profile number **06**

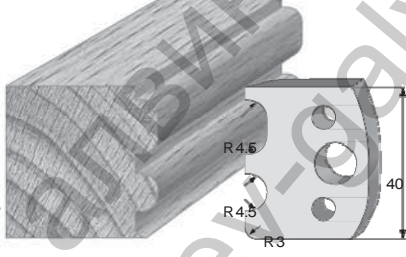

Profile number **07**

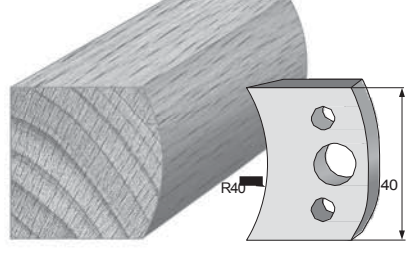

Profile number **08**

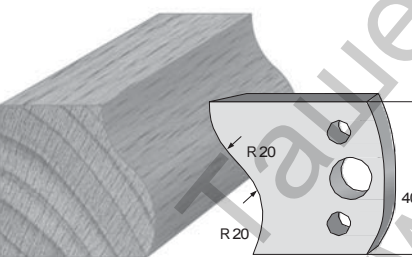

Profile number **09**

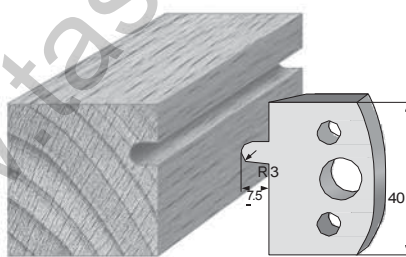

Profile number **10**

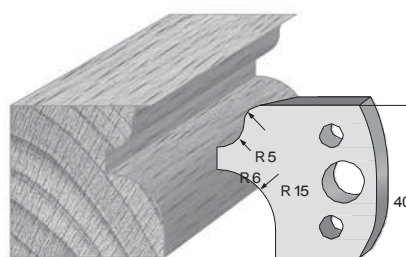

Profile number **11**

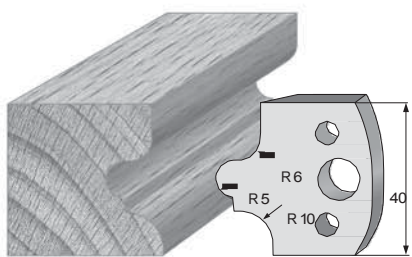

Profile number **12**

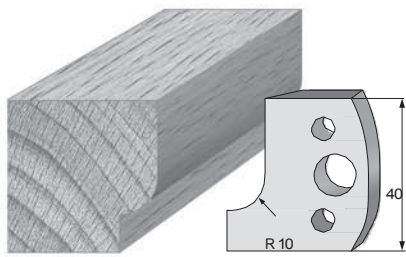

Profile number **13**

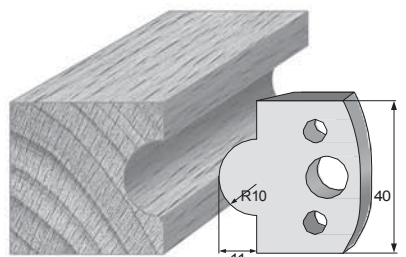

Profile number **14**

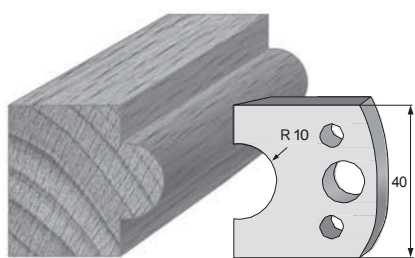

Profile number **15**

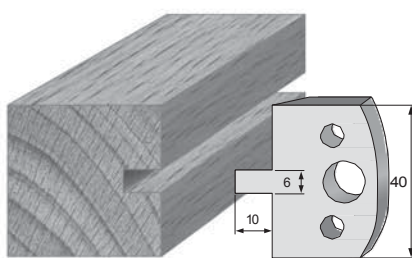

Profile number **16**

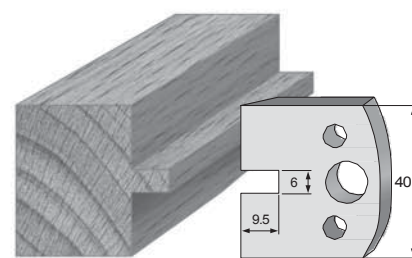

Profile number **17**

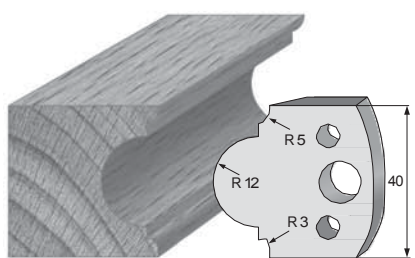

Profile number **18**

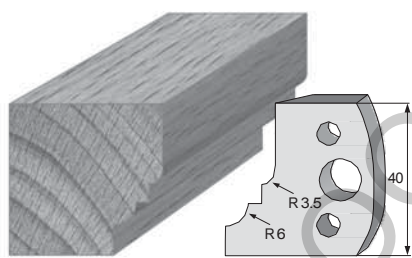

Profile number **19**

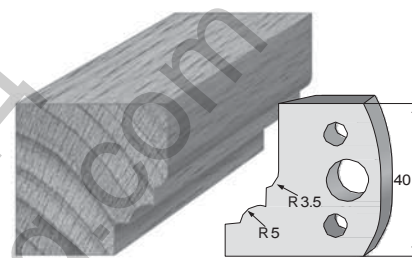

Profile number **20**

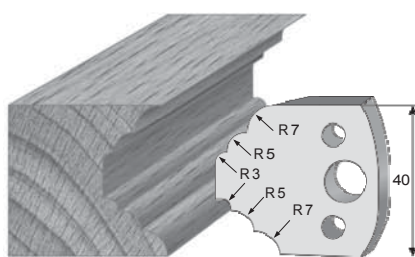

Profile number **21**

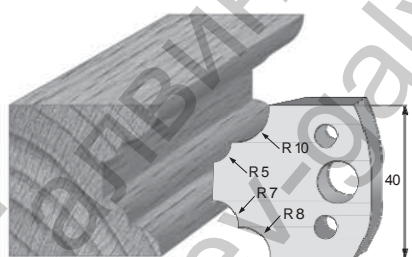

Profile number **22**

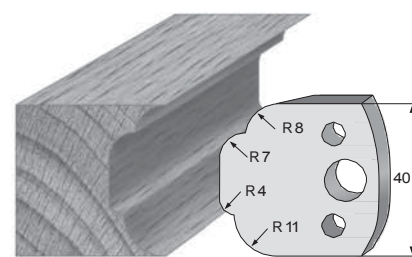

Profile number **23**

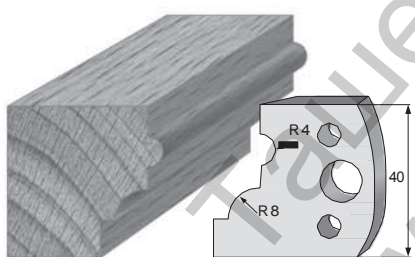

Profile number **24**

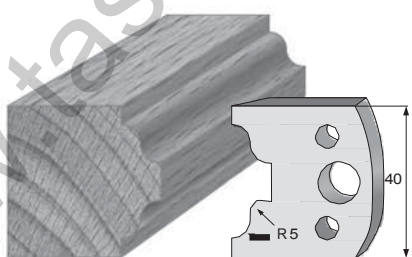

Profile number **25**

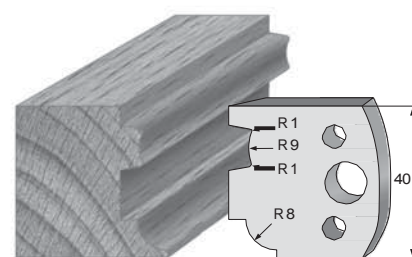

Profile number **26**

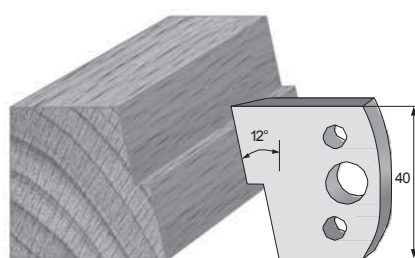

Profile number **27**

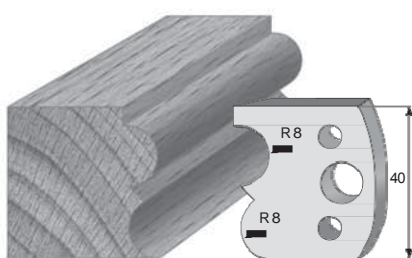

Profile number **28**

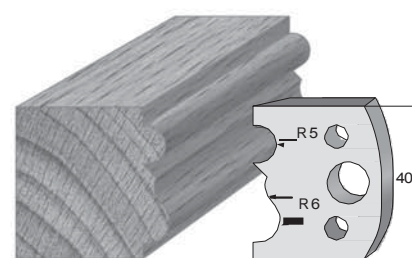

Profile number **29**

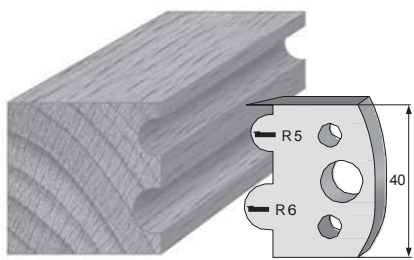

Profile number 30

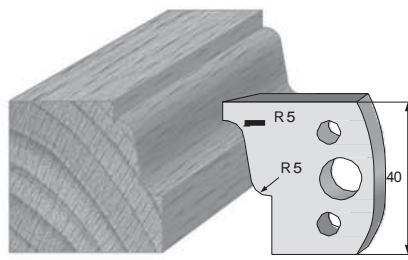

Profile number 31

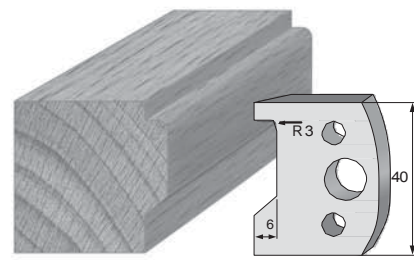

Profile number 32

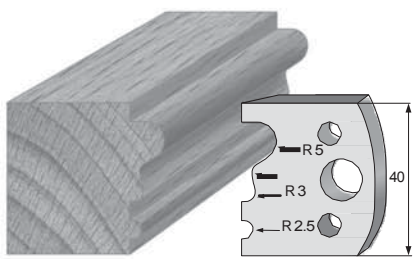

Profile number 33

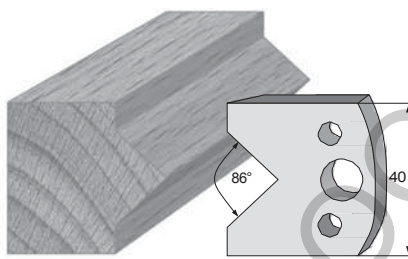

Profile number 34

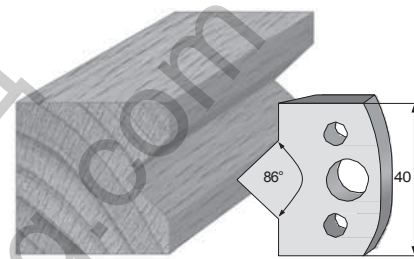

Profile number 35

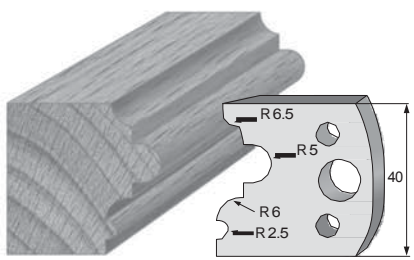

Profile number 36

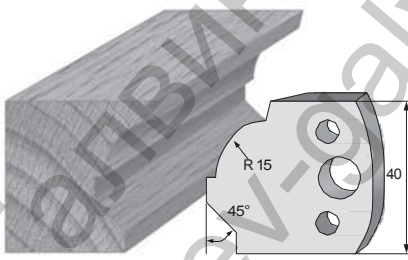

Profile number 37

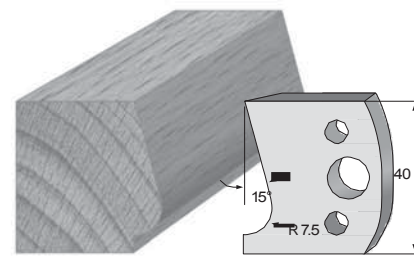

Profile number 38

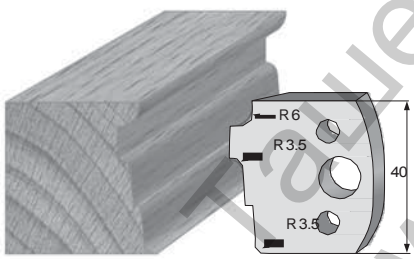

Profile number 39

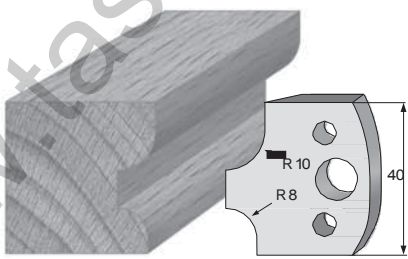

Profile number 40

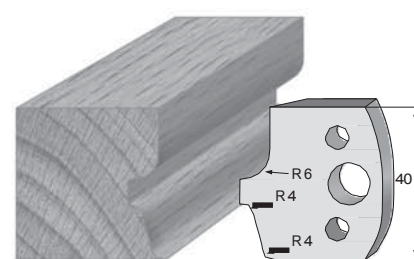

Profile number 41

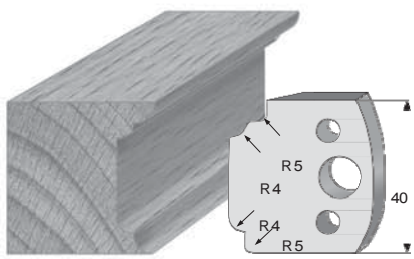

Profile number 42

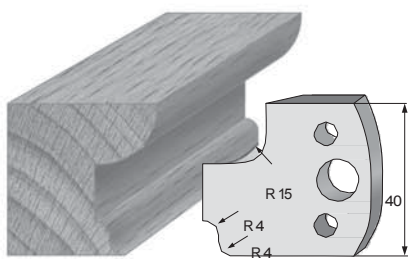

Profile number 43

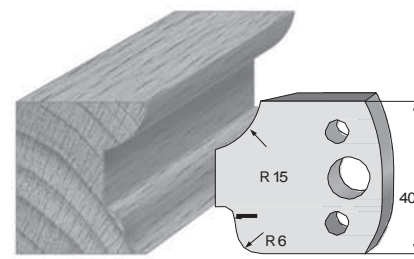

Profile number 44

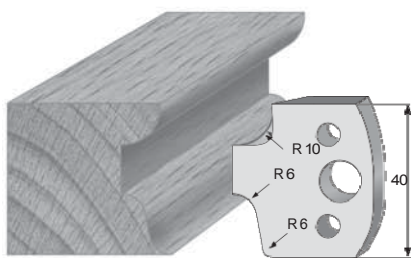

Profile number 45

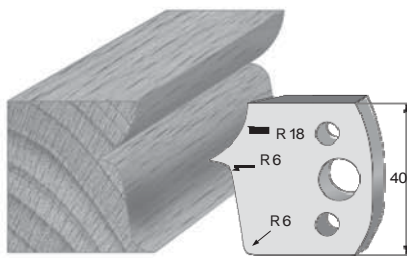

Profile number 46

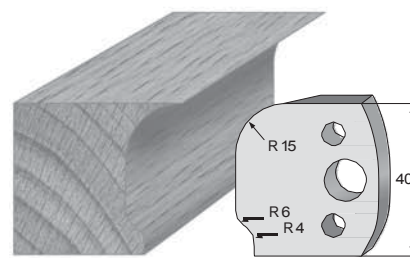

Profile number 47

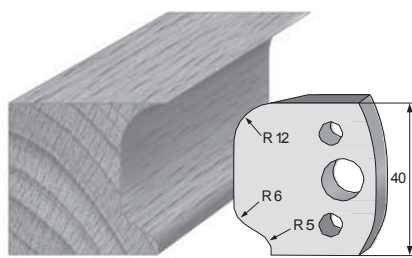

Profile number 48

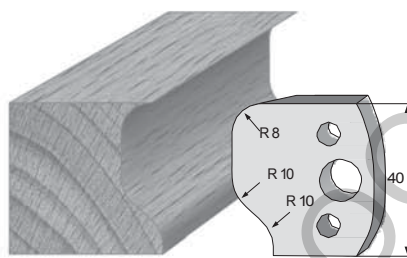

Profile number 49

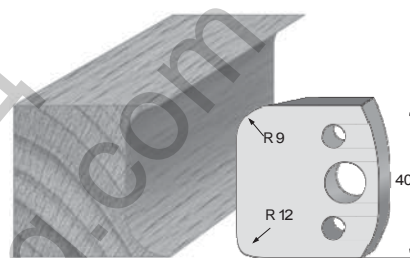

Profile number 50

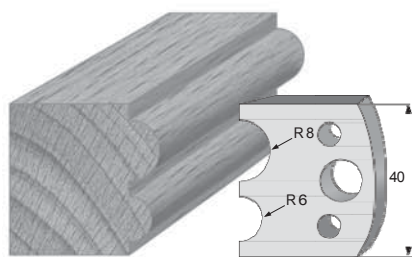

Profile number 51

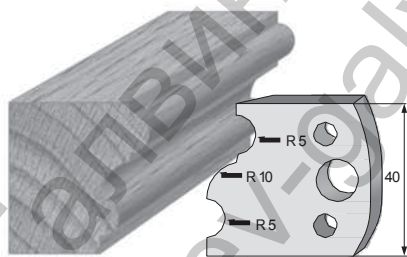

Profile number 52

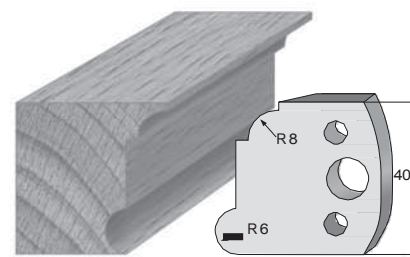

Profile number 53

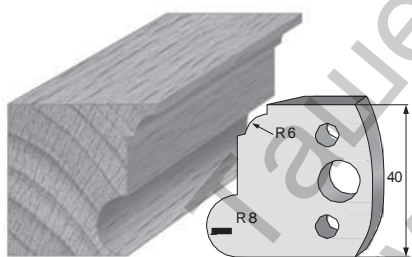

Profile number 54

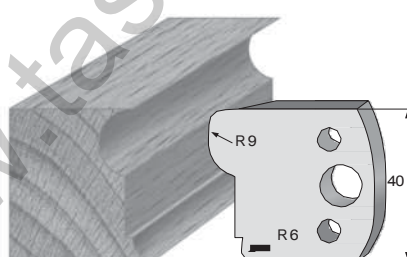

Profile number 55

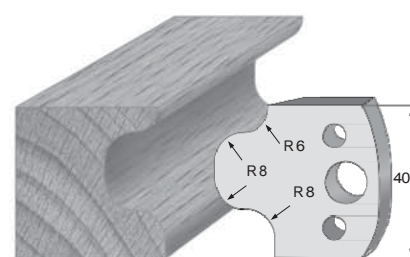

Profile number 56

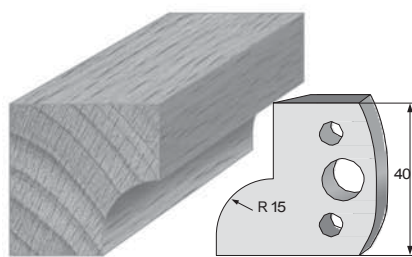

Profile number 57

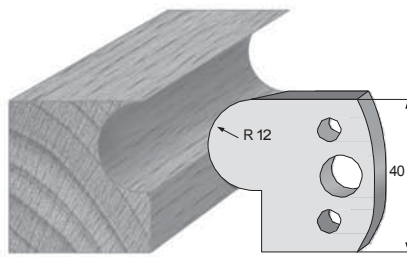

Profile number 58

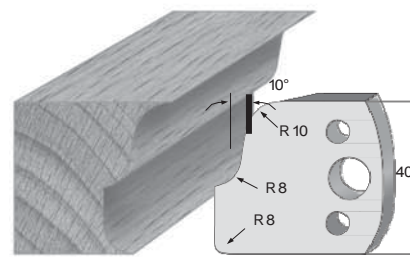

Profile number 59

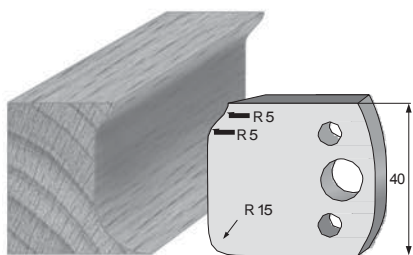

Profile number 60

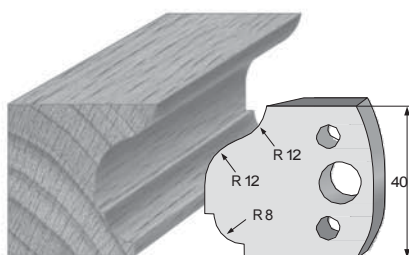

Profile number 61

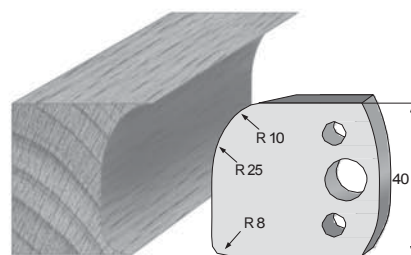

Profile number 62

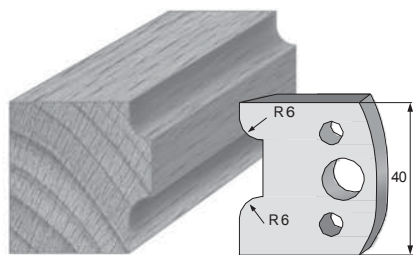

Profile number 63

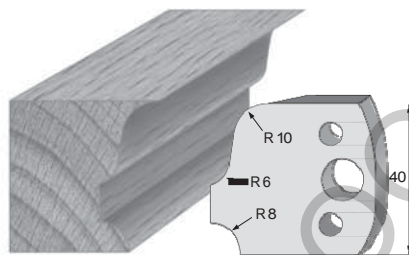

Profile number 64

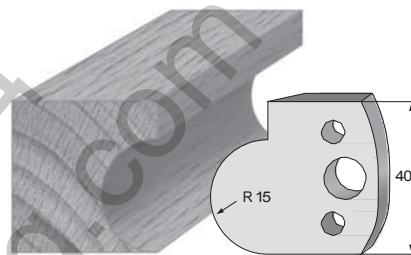

Profile number 65

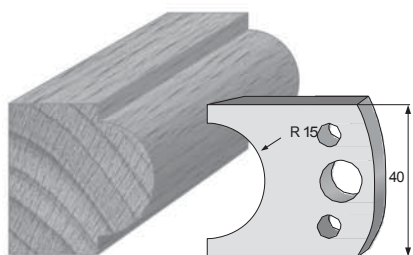

Profile number 66

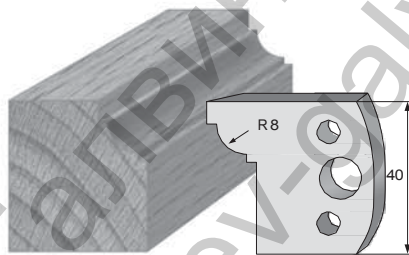

Profile number 67

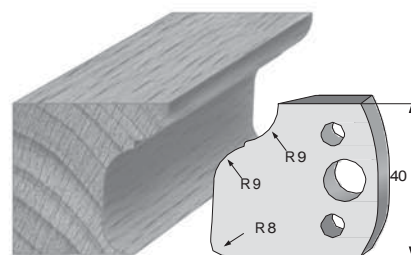

Profile number 68

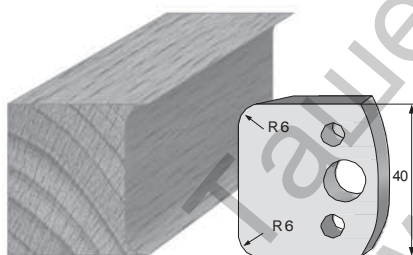

Profile number 69

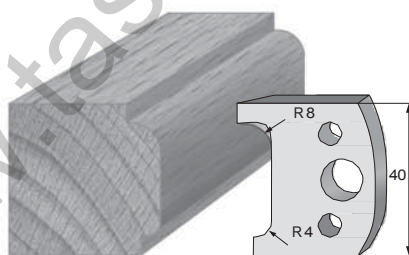

Profile number 70

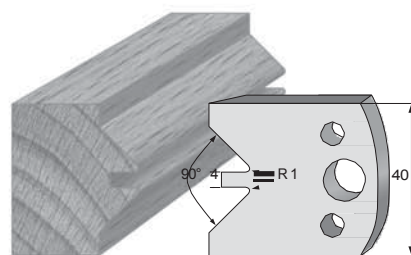

Profile number 71

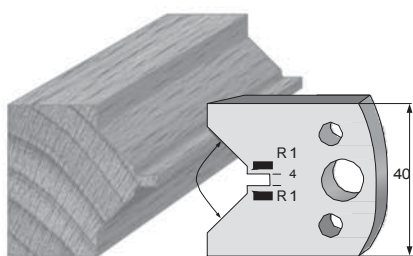

Profile number 72

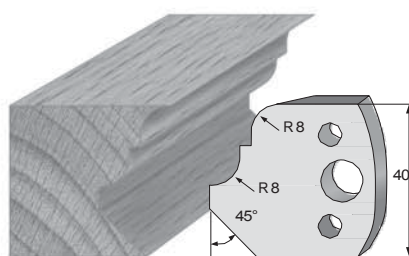

Profile number 73

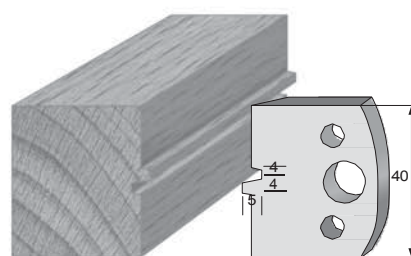

Profile number 74

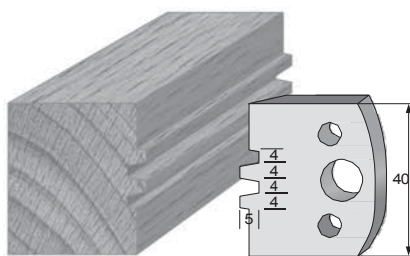

Profile number **75**

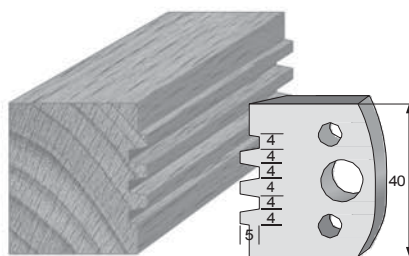

Profile number **76**

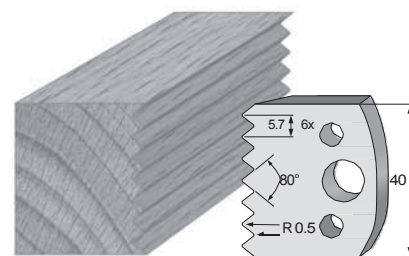

Profile number **77**

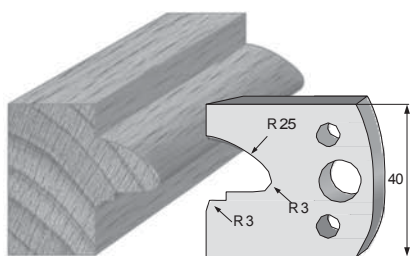

Profile number **78**

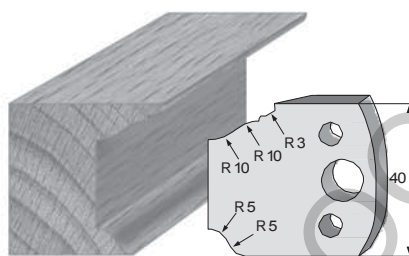

Profile number **79**

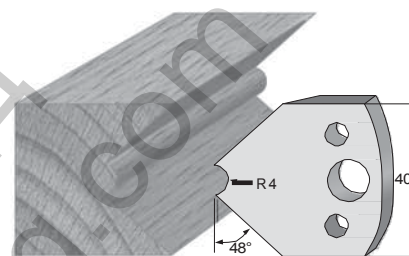

Profile number **80**

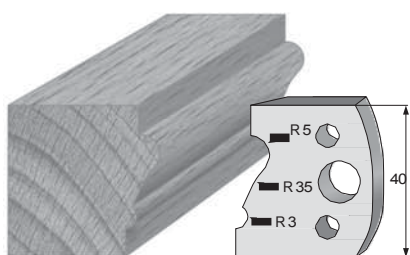

Profile number **81**

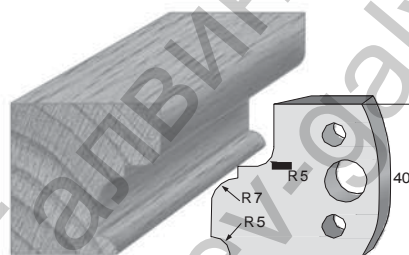

Profile number **82**

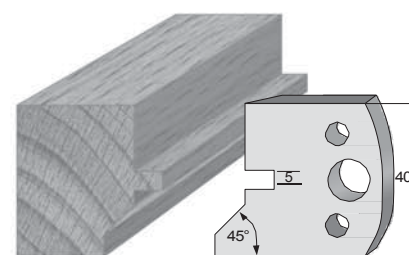

Profile number **83**

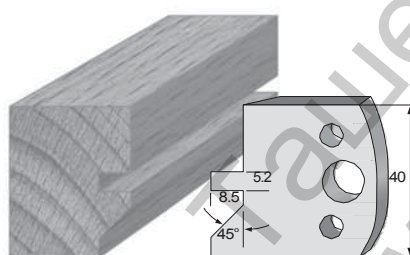

Profile number **84**

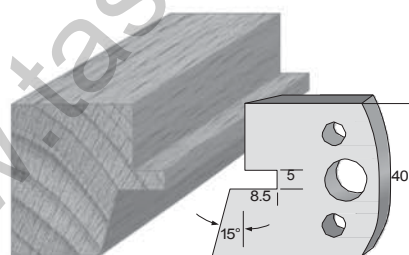

Profile number **85**

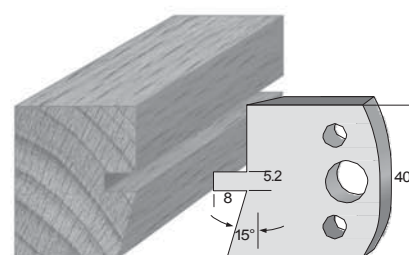

Profile number **86**

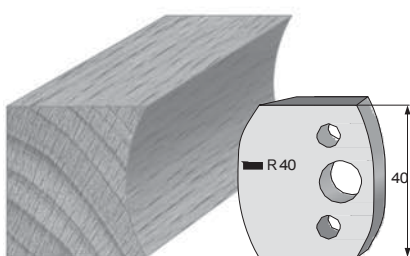

Profile number **87**

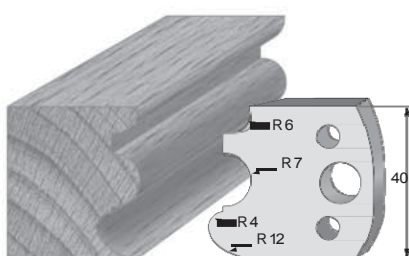

Profile number **88**

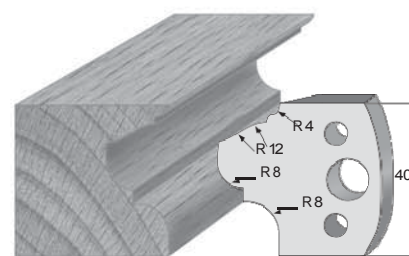

Profile number **89**

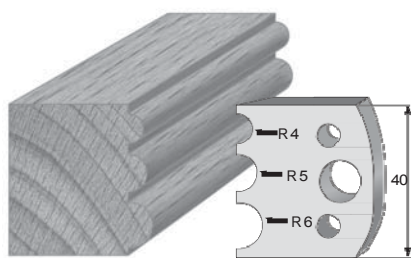

Profile number **90**

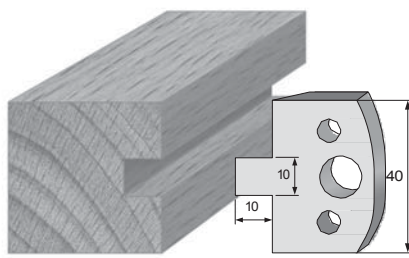

Profile number **91**

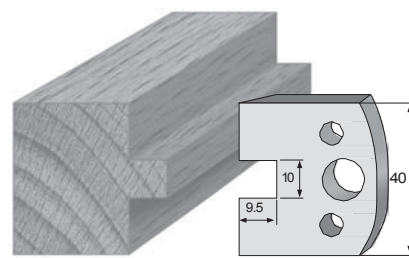

Profile number **92**

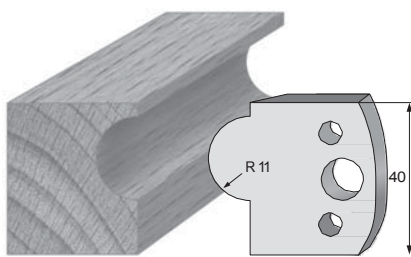

Profile number **93**

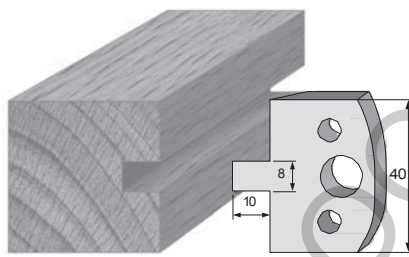

Profile number **94**

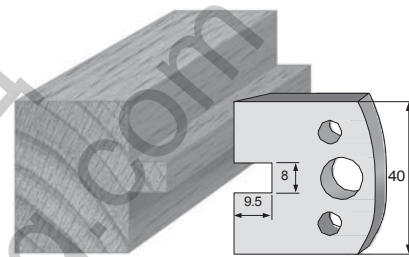

Profile number **95**

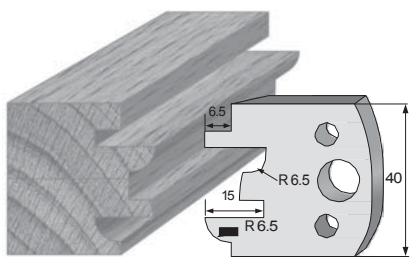

Profile number **96**

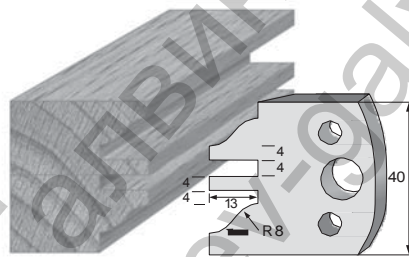

Profile number **97**

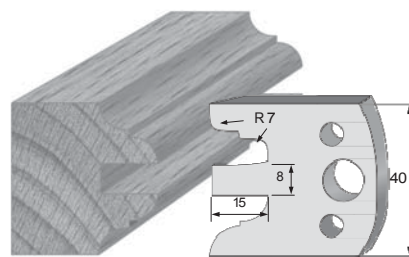

Profile number **98**

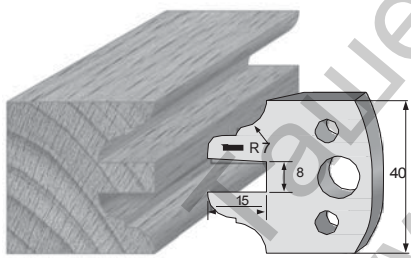

Profile number **99**

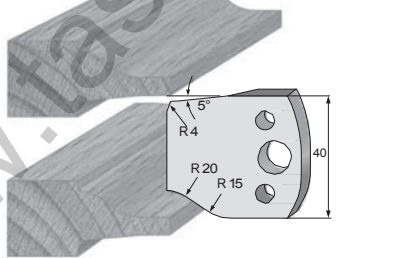

Profile number **100**